



Acquirer Systems
www.acquirer.com

Total product testing for the global payments industry

www.acquirer.com



Acquirer Systems
www.acquirer.com

Acquirer Systems

Customer Conference

Thursday 28th February

Radisson SAS Royal Hotel
Dublin, Ireland

Total product testing for the global payments industry

www.acquirer.com

Agenda

Technical Stream



Acquirer Systems
www.acquirer.com

- Session introduction
- Customer introduction
- Software use cases and architecture
- Customer implementation
- What's new since last year
- What's planned this year
- In retrospect...!
- Demos
 - Security Analyzer
 - End to end transaction
 - Stress test
- GCIS test cases
- Feedback

Total product testing for the global payments industry

www.acquirer.com

Technical Software Use Cases



The Payment World

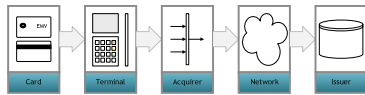

Total product testing for the global payments industry

www.acquirer.com

Technical Vendor Use Cases

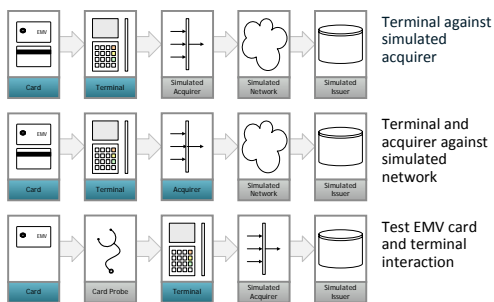

Total product testing for the global payments industry

www.acquirer.com

Technical Vendor Use Cases



- Verified by major acquirers
- Supports Visa ADVT & MasterCard ETEC
- Real-time validation of results
- Detailed message and communication audits
- Pre-certification reporting
- Rapid turnaround of results
- Inhouse testing on developer desktop, not outhouse testing in acquirer

Total product testing for the global payments industry

www.acquirer.com

Technical

Issuer Use Cases



- Single test environment
- Virtual, keyed, mag-strip, ICC card entry, mail-order and others
- Full EMV cryptographic support
- 3-DES for on-line PIN
- Stress testing as standard
- Regression testing
- Multi-port, multi-session testing

Total product testing for the global payments industry

www.acquirer.com

Technical

Settlement

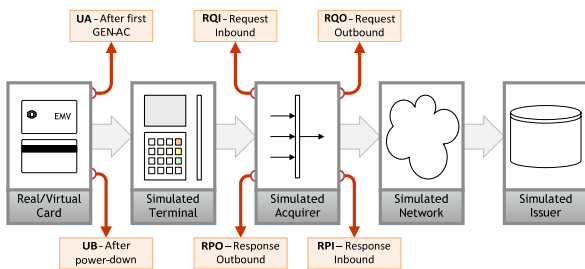

Total product testing for the global payments industry

www.acquirer.com

Technical

Architecture

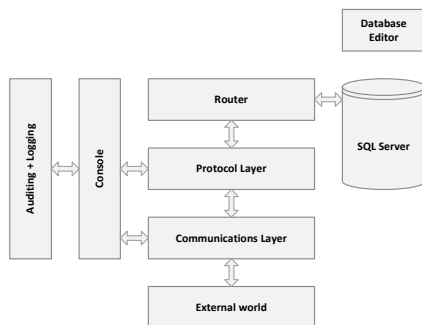

Total product testing for the global payments industry

www.acquirer.com

Technical
Communications Layer

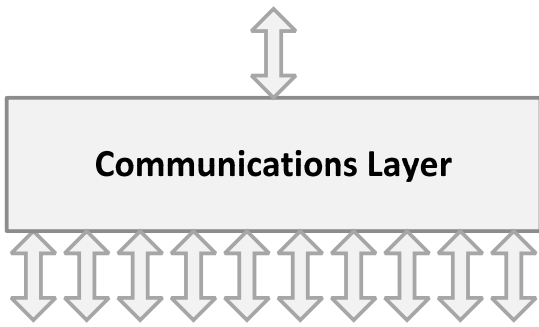

Total product testing for the global payments industry www.acquirer.com

Technical
Protocol Layer – Static Mode

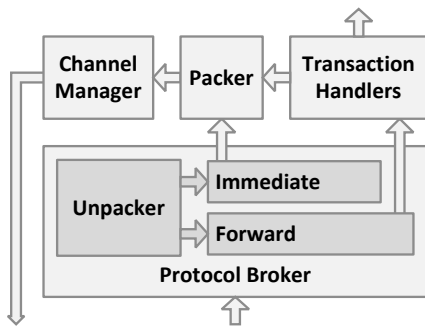

Total product testing for the global payments industry www.acquirer.com

Technical
Protocol Layer – Dynamic Mode

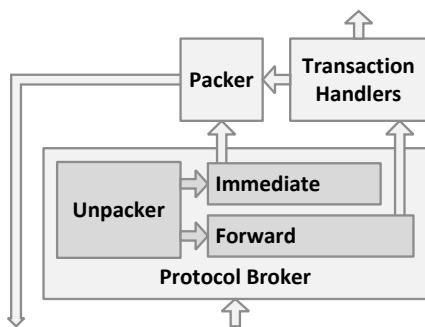

Total product testing for the global payments industry www.acquirer.com

Technical

Router Layer



Acquirer Systems
www.acquirer.com

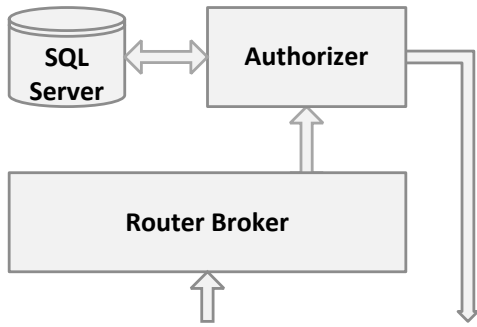

Total product testing for the global payments industry

www.acquirer.com

Technical

Out in the real world...



Acquirer Systems
www.acquirer.com

Over to Brian!

Total product testing for the global payments industry

www.acquirer.com

Technical

What's was new in 2007



Acquirer Systems
www.acquirer.com

- Message Viewer
- ETEC 7.0
- GCIS
- Other handlers
- New cryptographic schemes
- Changes to EMVICC
- Virtual 8583
- Follow-on, SRQ, SRP

Total product testing for the global payments industry

www.acquirer.com

Technical

What's new in 2008



- New UI
- SCIM talk

Total product testing for the global payments industry

www.acquirer.com

Technical

If only they'd told me...



Over to Brian!

Total product testing for the global payments industry

www.acquirer.com

Technical

Demo – Security Analyzer



- New tool to be included shortly
- Freely distributable
- Includes
 - Key component merging
 - Single and triple DES encode/decode
 - PIN block encode/decode
 - CVV generation
- More to come...

Total product testing for the global payments industry

www.acquirer.com

Technical

Bulk Generator



- Developed for SAMA
- Generates from transaction matrix
 - Large databases
- Creates corresponding checkpoints

Total product testing for the global payments industry

www.acquirer.com

Technical

Demo – End to End Transaction

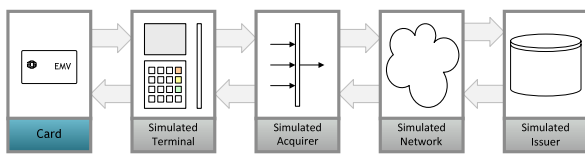

Total product testing for the global payments industry

www.acquirer.com

Technical



Stress Testing



Total product testing for the global payments industry

www.acquirer.com

Technical

Stress Testing



- Not as easy as it looks!
- Start off with simple transactions
 - Build it up
- Start off slow
 - Build it up
- Start off with one transaction in-flight
 - Build it up
- Mix transaction types

Total product testing for the global payments industry

www.acquirer.com

Technical

Stress Testing



- Exercise your HSM farm incrementally
- Check out HSM synchronicity
- Be aware of switch load-balancing
- Multiple ports?
- Record locking?
- Graph everything
- Make sure it all makes sense
- Repeat!

Total product testing for the global payments industry

www.acquirer.com

Technical

Stress Testing



- Demo...

Total product testing for the global payments industry

www.acquirer.com

Technical

GCIS Database



- GCIS – New MasterCard global standard
- 700 Acquirer test cases (ATM, POS, eCommerce)
- 1000 Issuer test cases
- Used to test and validate acquirer and issuer switches

Total product testing for the global payments industry

www.acquirer.com

Technical

Feedback



- Input required!

Total product testing for the global payments industry

www.acquirer.com
